

Article number: 201242825

Description: E+G
Pin with axial lock GN 124.2-8-25

Measures

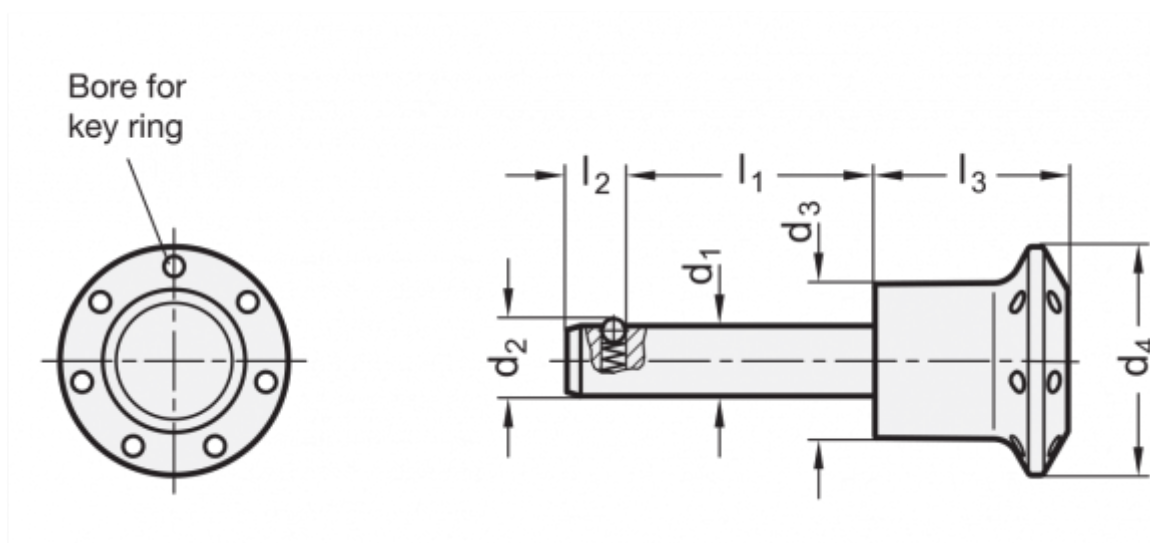

Axial grasping power on pins N = 15

Bore for pin D12 = 8

d1 = 8

d2 = 8.7

d3 = 14.5

d4 = 25

Dividing power (double) in kN = 40

l1 = 25

l2 = 6.3

l3 = 22.5